

PLAN

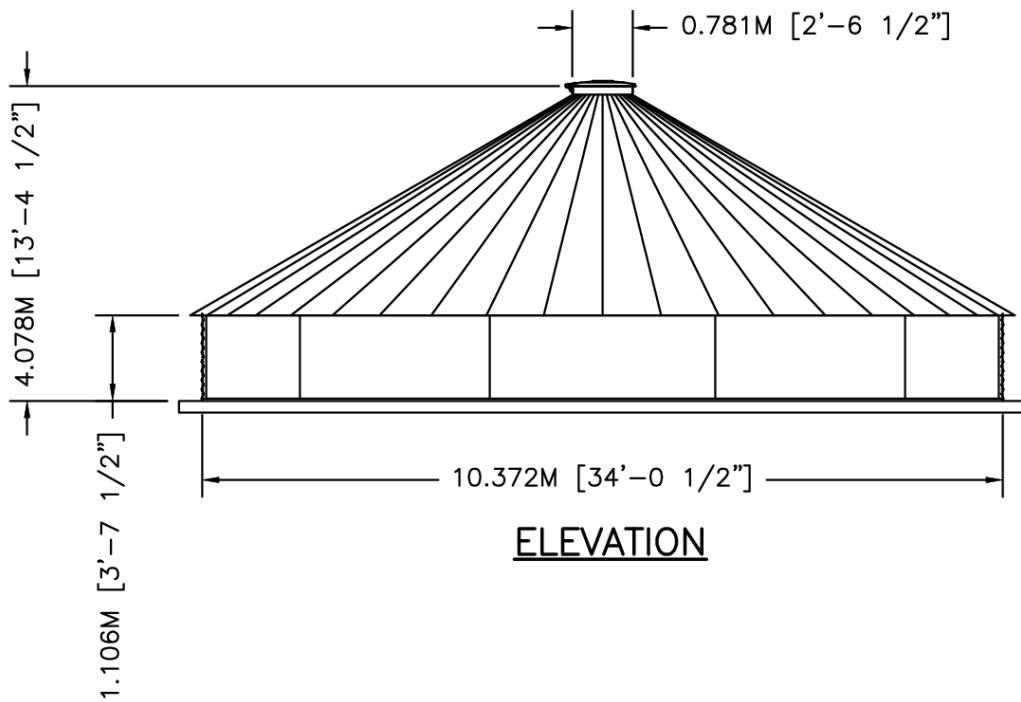

ELEVATION



	BY	DATE	TITLE	
DWN	XXX	XX/XX/XX	WTU11-01 30"PR 30DEG V-RIB	
CKD			NOMINAL CAPACITY - 82.628 M3 [21,828 GAL]	
ENG			DWG. NO. SCT3401-VR WTU11-01	REV. NO.
SIZE: A		SCALE: 1/8"=1'-0"		SHEET 1 OF 1